

SMA ATTENUATOR
10 DB 2 GHZ 50/80W

R417.810.128
Series : ATTENUATOR

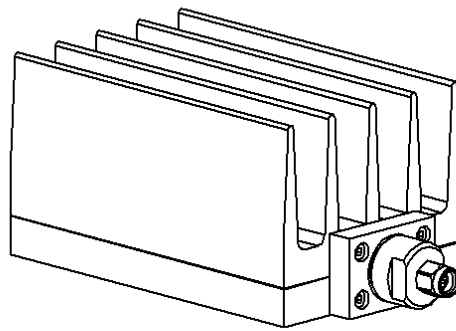

All dimensions are in mm.

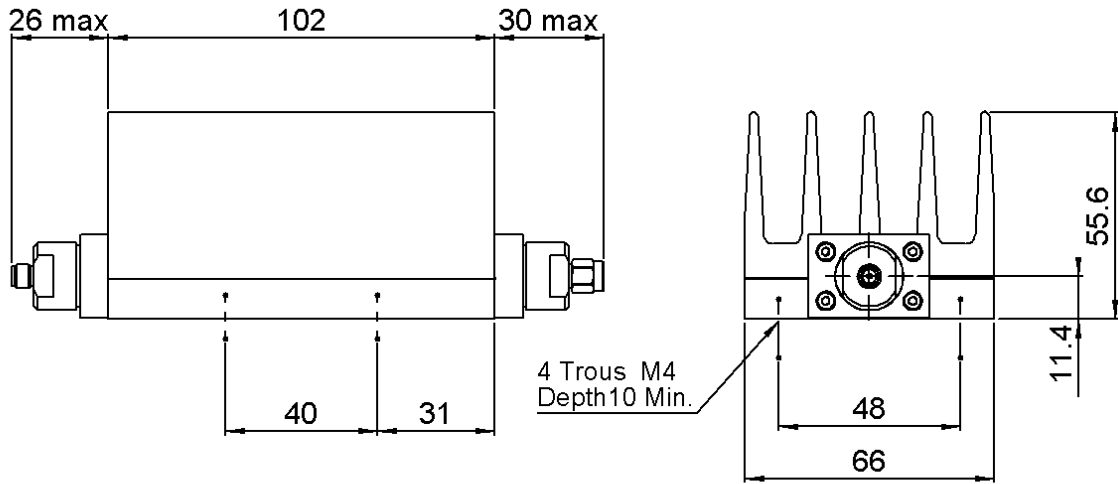

COMPONENTS	MATERIALS	PLATING(μm)
BODY	STAINLESS STEEL	PASSIVATED
MALE CENTER CONTACT	BERYLLIUM COPPER	GOLD 1.3 OVER NICKEL2
FEMALE CENTER CONTACT	BERYLLIUM COPPER	GOLD 1.3 OVER NICKEL2
OUTER CONTACT		
INSULATOR	PTFE	
GASKET	SILICONE RUBBER	
SUBSTRATE	ALUMINA	
RESISTOR	THICK FILM	
OTHERS PARTS	ALUMINIUM	BLACK PAINTING

Issue : 0843 A

In the effort to improve our products, we reserve the right to make changes judged to be necessary.



SMA ATTENUATOR
10 DB 2 GHZ 50/80W

R417.810.128
Series : ATTENUATOR

ELECTRICAL CHARACTERISTICS

Frequency (GHz)	DC - 1	1 - 2
V.S.W.R (≤)	1.10	1.25
Deviation(±dB)	1.0	1.0

Operating Frequency Range	DC - 2	GHz
Impedance	50	Ω
Nominal Attenuation	10	dB
Peak power at 25°C (1μs, 1%)	5000	W
Average power at 25°C	50	W (Free Air Cooled)
	80	W (Conduction Cooled)
For conduction cooling, a plate 1000 cm ² x 3 mm(156 sq.in*1/8) min. is required		

MECHANICAL CHARACTERISTICS

Connectors	SMA	Male Female	MIL-C 39012
Weight	606,0700 g		

ENVIRONMENTAL CHARACTERISTICS

Operating temperature range	-55 /+125 °C
Storage temperature range	-55 /+125 °C

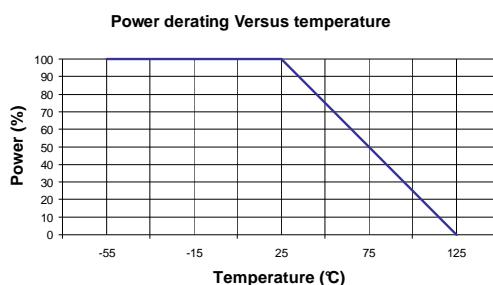

SPECIFICATION

OTHER CHARACTERISTICS

Issue : 0843 A

In the effort to improve our products, we reserve the right to make changes judged to be necessary.

